

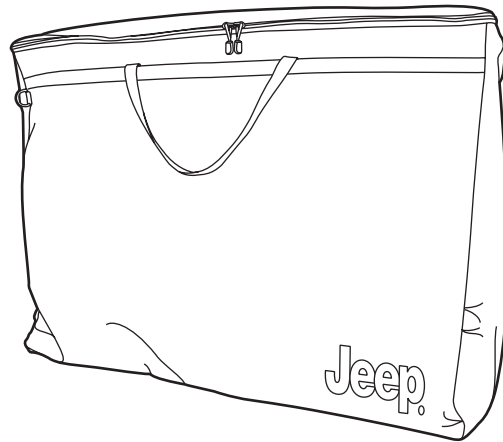

JK WRANGLER

Half Door and Window Storage Bag



82210548

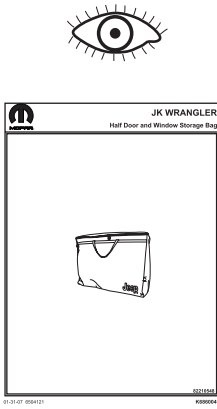

A

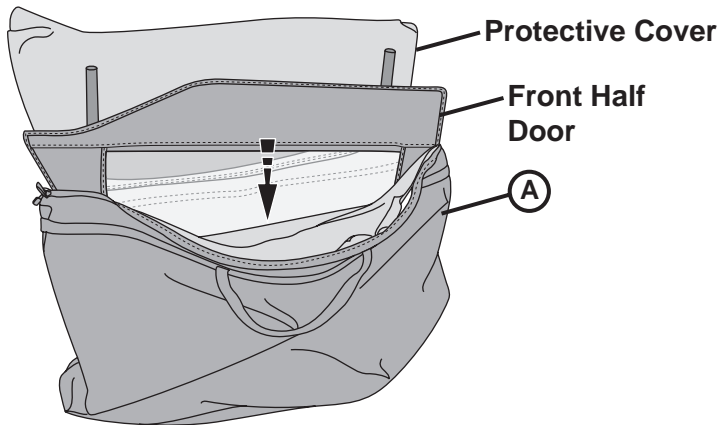
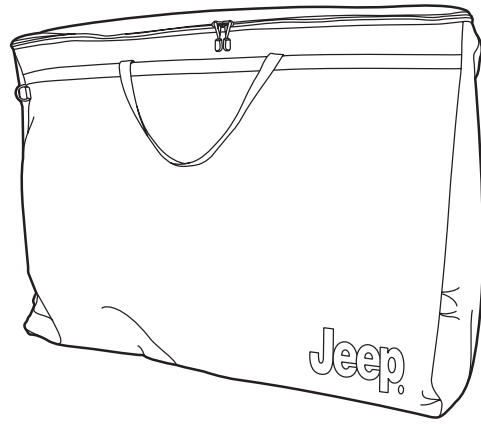

Orient a front half door with the legs up and place it in the rear compartment of the bag.

1

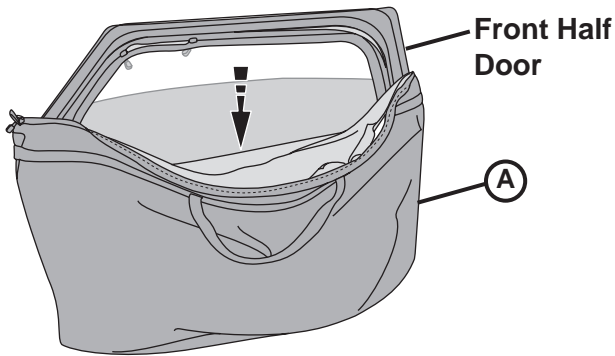

Wrap protective cover over half door. Orient the second front half door with the legs down and place it in next compartment.

2

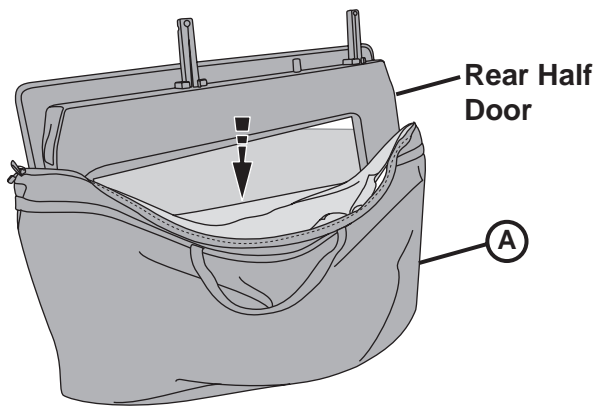

Orient a rear half door with the legs up and place it in the third compartment of the bag.

3

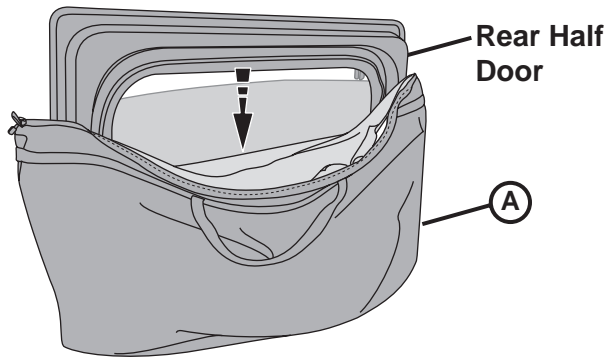

Wrap protective cover over half door. Orient the second rear half door with the legs down and place it in the last compartment.

4

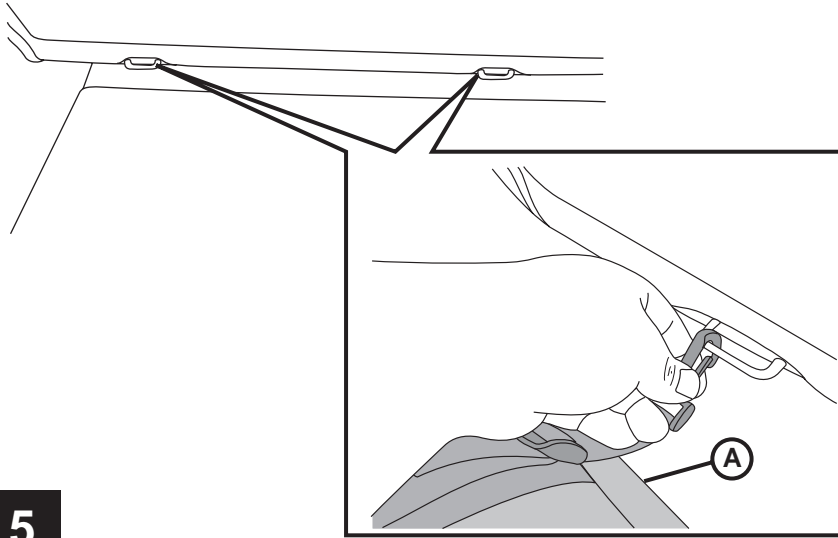

Hook the two hooks on the bottom of the bag to the child restraints on the bottom of the rear seat.

5

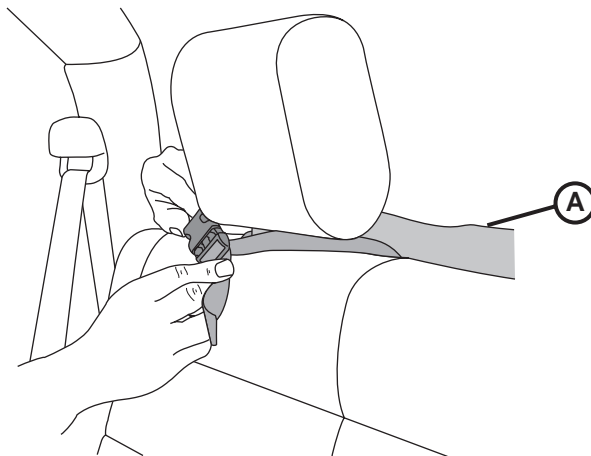

Hook the two straps on the top of the bag around the headrests on the rear seat and fasten the buckles.

6

Note: To store the windows, you will need a 3 Compartment Storage Bag, part # 82210326.

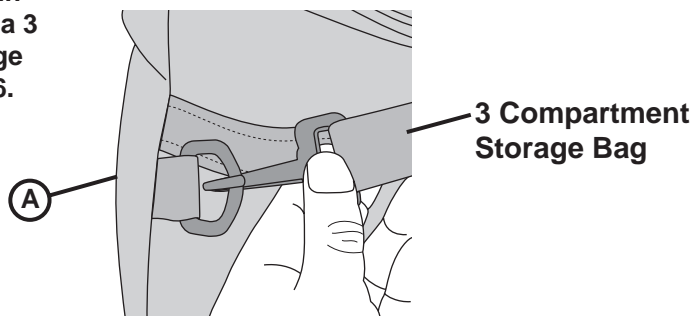

If you have the storage bag, roll it and attach it to the D-Rings on the side of the Half Door Storage Bag.

7



JK WRANGLER

Sac de rangement pour demi-portière et demi-fenêtre

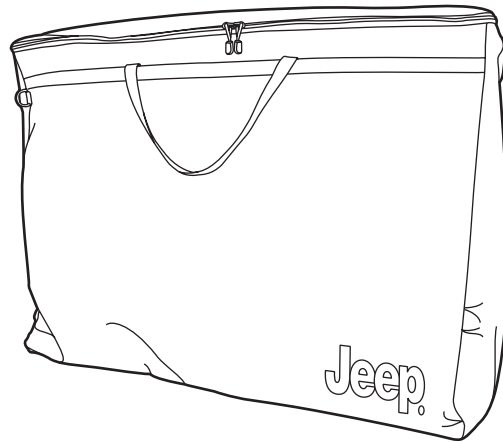

82210548

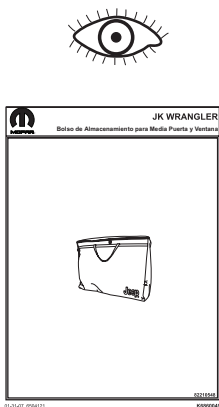

A

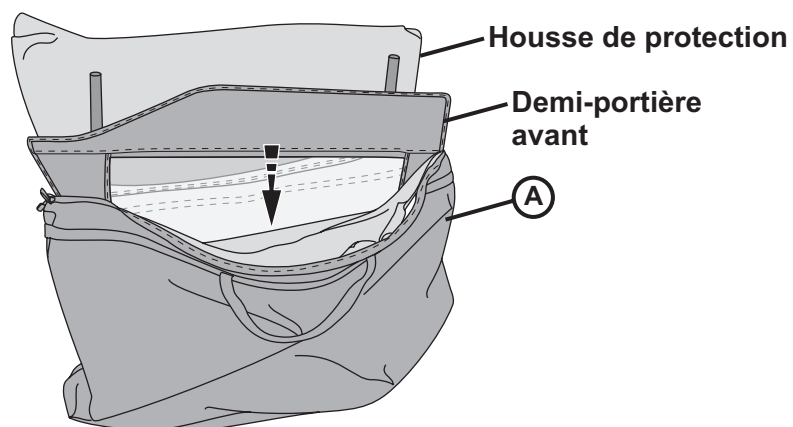
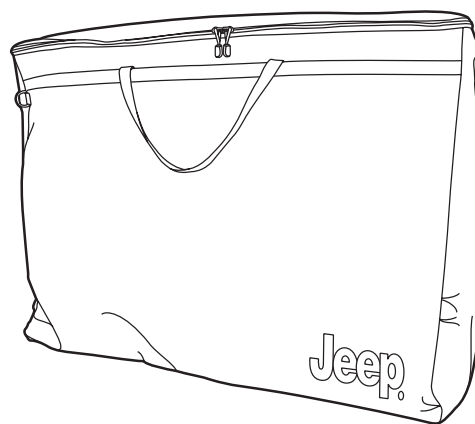

Orienter la demi-portière avant avec les pattes vers le haut et placez-la dans le compartiment arrière du sac.

1

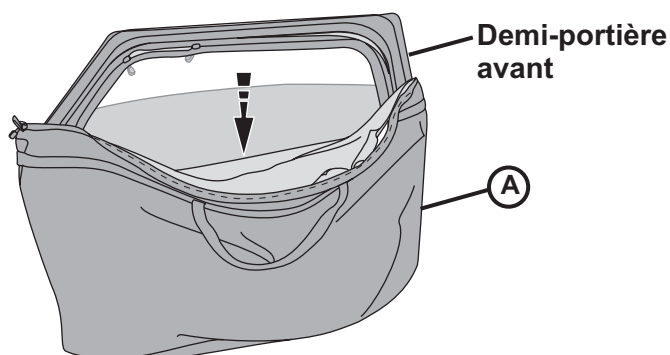

Enrouler la housse de protection par-dessus la demi-portière. Orienter la deuxième demi-portière avec les pattes vers le bas et placez-la dans le prochain compartiment.

2

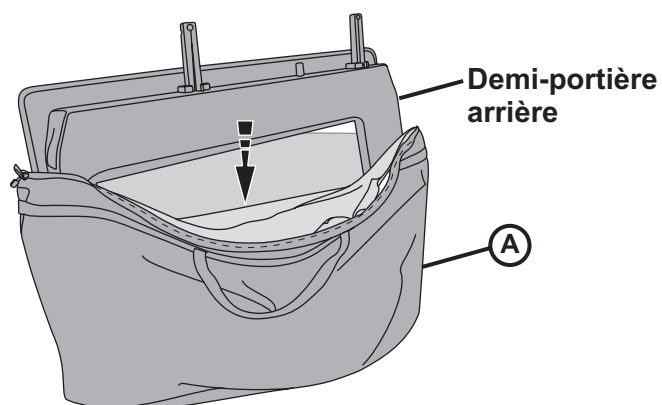

Orienter la demi-portière arrière avec les pattes vers le haut et placez-la dans le troisième compartiment du sac.

3

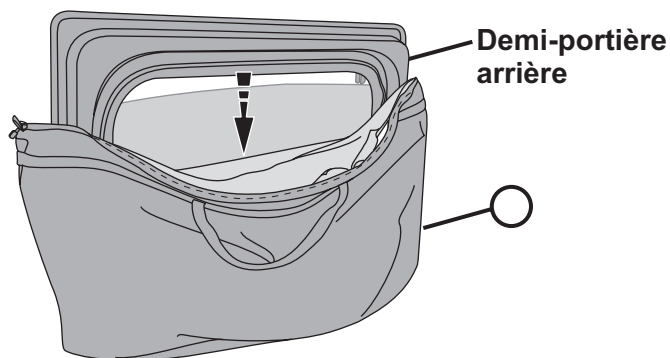

Enrouler la housse de protection par-dessus la demi-portière. Orienter la deuxième demi-portière arrière avec les pattes vers le bas placez-la dans le dernier compartiment

4

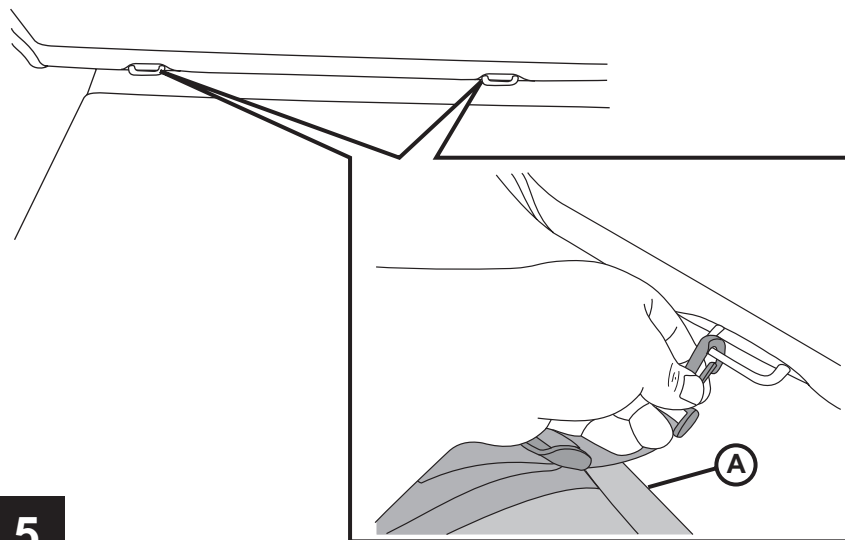

Fixer les deux crochets qui sont à la base du sac au dispositif de protection pour enfants situé en bas du siège arrière.

5

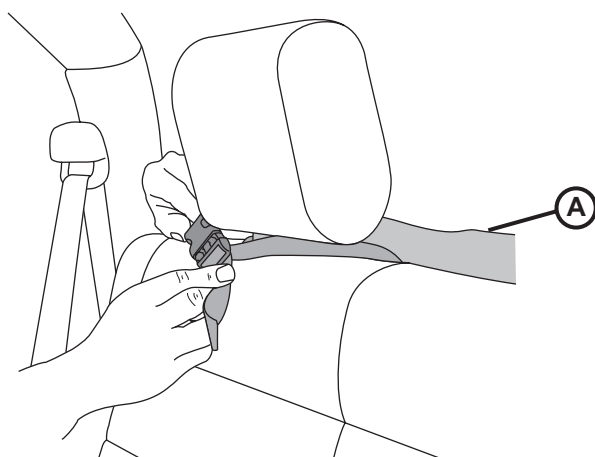

Fixer les deux sangles en haut du sac autour des appui-tête sur le siège arrière et serrer les boucles.

6

Remarque : Pour entreposer les fenêtres, vous aurez besoin d'un sac de rangement à 3 compartiments, pièce # 82210326.

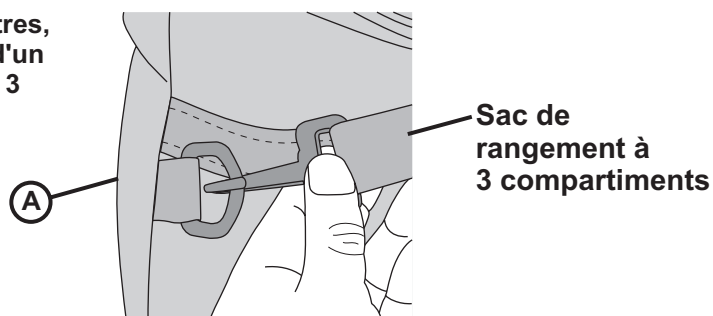

Si vous avez le sac de rangement, roulez-le et attachez-le aux anneaux en forme de D sur le côté du sac de rangement de demi-portière.

7



JK WRANGLER

Bolso de Almacenamiento para Media Puerta y Ventana

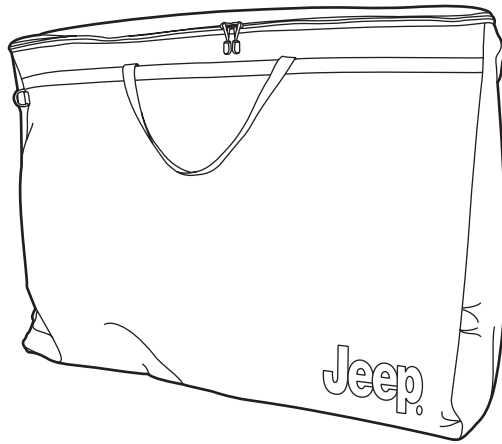

82210548

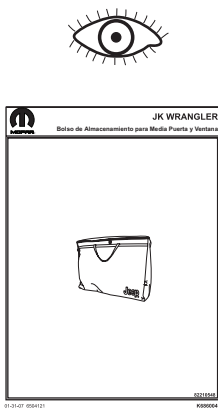

A

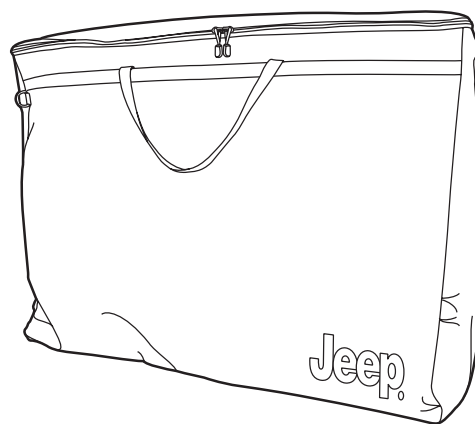

1

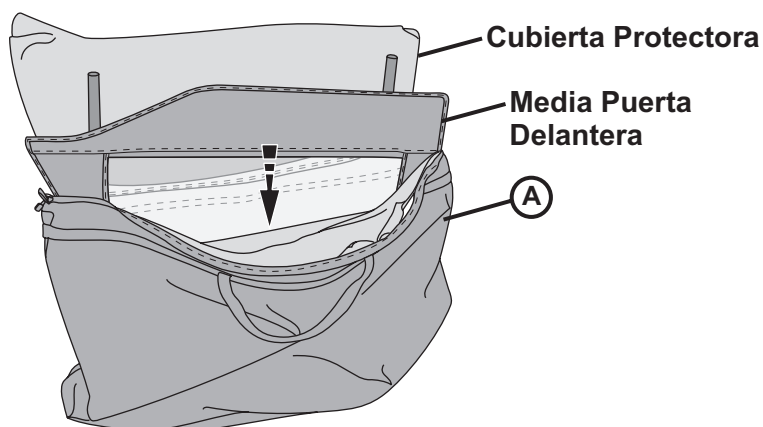

Dirija una media puerta delantera con las patas hacia arriba y colóquela en el compartimiento trasero de la bolsa

2

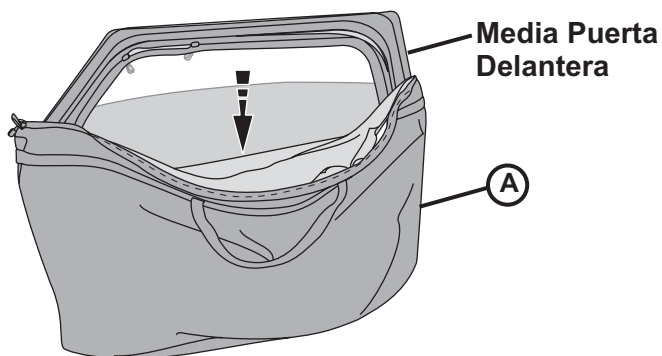

Enfunde la media puerta dentro de la cubierta protectora. Coloque la segunda media puerta delantera con las patas hacia abajo y colóquela en el próximo compartimiento.

3

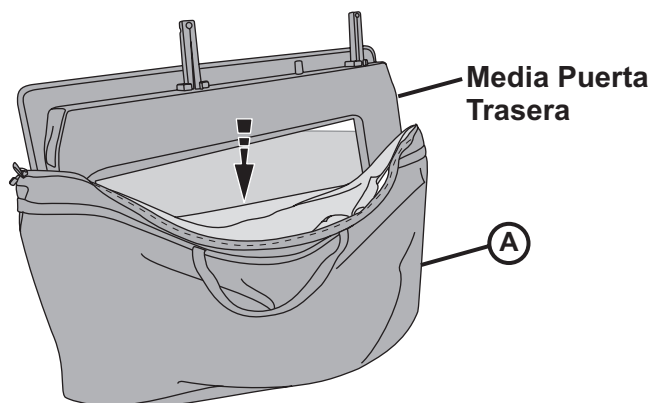

Coloque una media puerta trasera con las patas hacia arriba y colóquela en el tercer compartimiento de la bolsa.

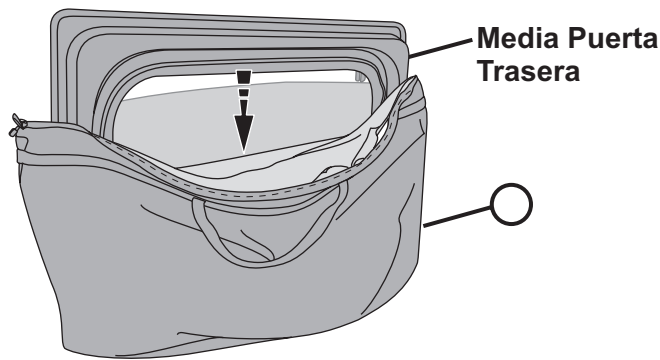

Enfunde la media puerta dentro de la cubierta protectora. Coloque la segunda media puerta trasera con las patas hacia abajo y colóquela en el último compartimiento.

4

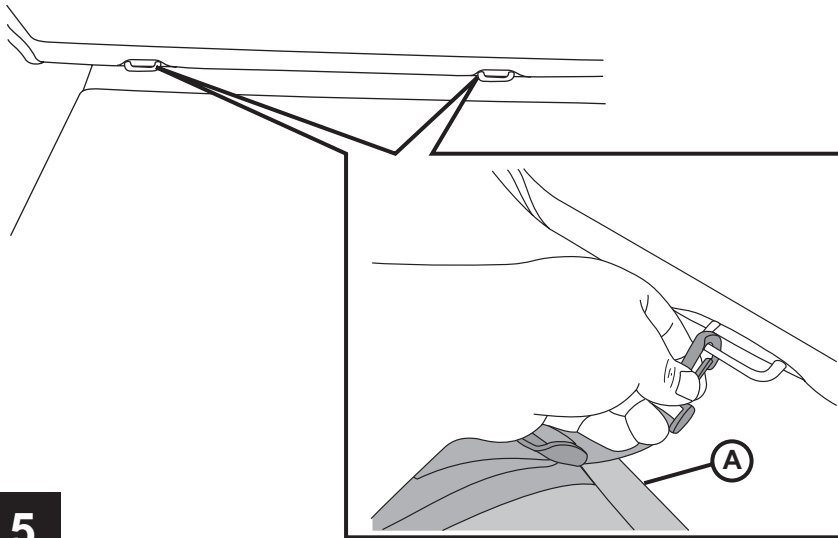

Enganche y asegure los dos ganchos, ubicados en el fondo del bolso, a los anclajes para retención de infantes en el fondo del asiento trasero.

5

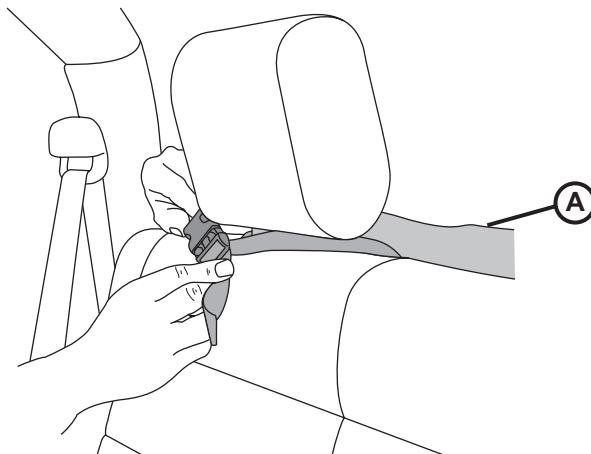

Enganche las dos correas en el tope del bolso alrededor de las cabeceras, en el asiento trasero y enganche las hebillas.

6

Nota: Para guardar las ventanas usted necesitará de un Bolso de Almacenamiento con 3 Compartimientos, No de parte 82210326.

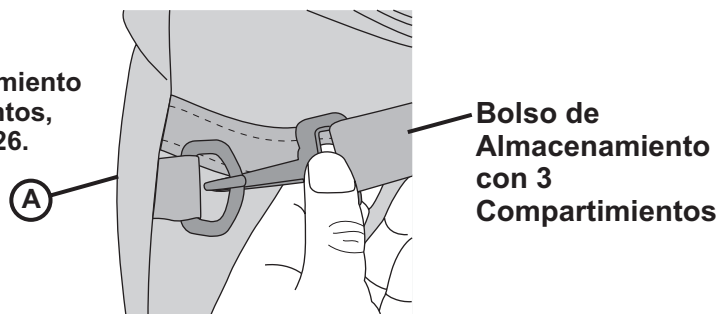

Si usted posee un bolso de almacenamiento, enróllelo y asegúrelo a los Anillos en D en el costado del Bolso de Almacenamiento para Media Puerta.

7